

20 to 85 W Programmable Constant Current Class 2 LED Driver with 0-10 V Dimming

Input Voltage	Max. Output Power	Efficiency	Max. Case Temperature	THD	Power Factor	Dimming Method	Dimming Range	Startup Time
120 - 277 Vac	85 W	up to 90% typical	90°C (measured at the hot spot)	< 20%	> 0.9	Programmable 0 - 10 V	1 - 100%	300 ms typical

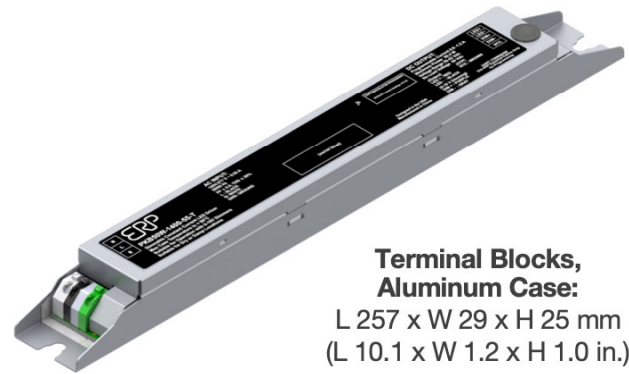
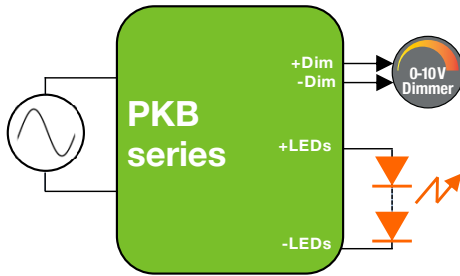

Terminal Blocks, Aluminum Case:
L 257 x W 29 x H 25 mm
(L 10.1 x W 1.2 x H 1.0 in.)

PKB85:
L 425 x W 29 x H 25 mm
(L 16.7 x W 1.2 x H 1.0 in.)

FEATURES

- UL Class P
- Class 2 output
- Lifetime: 5 years @ Tc ≤ 75°C
- 90°C maximum case hot spot temperature
- Surge protection:
 - IEC61000-4-5: 2 kV line to line/2 kV line to earth
 - 2.5 kV ring wave: ANSI/IEEE c62.41.1-2002 & c62.41.2-2002 category A
- Complies with ENERGY STAR®, DLC (DesignLight Consortium®), and CA Title 24 technical requirements

PROGRAMMING

- Audio jack programming
- Current: see page 2 for current range
- 0-10V dimming profiles: Linear, Non-linear, Logarithmic
- Data log read: SKU, S/N, lot code, hours of operation, FW rev., power cycles

APPLICATIONS

- Commercial & residential lighting
- Architectural lighting
- Indoor Lighting

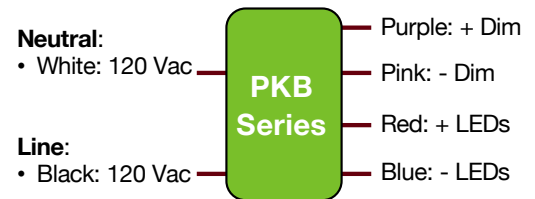

Wiring Diagrams



20 to 85 W Programmable Constant Current Class 2 LED Driver with 0-10 V Dimming

1 - ORDERING INFORMATION

Part Number	Nominal Input Voltage (Vac)	Max Output Power (W)	Iout (mA)	Default Programmed Current (mA)	Vout Min. (Vdc)	Vout Nom. (Vdc)	Vout Max. (Vdc)*	Open Loop (No Load) Voltage (Vdc)	Notes
PKB20W									
PKB20W-0700-55-TN	120 & 277	20	100 to 700	350	10	49.5	55	60	Terminal Blocks
PKB30W									
PKB30W-1050-55-TN	120 & 277	30	275 to 1050	700	10	49.5	55	60	Terminal Blocks
PKB50W									
PKB50W-1400-55-TN	120 & 277	50	500 to 1400	1050	10	49.5	55	60	Terminal Blocks
PKB65W									
PKB65W-1800-55-TN	120 & 277	65	600 to 1800	1200	10	49.5	55	60	Terminal Blocks
PKB85W									
PKB85W-2300-55-TN	120 - 277	85	700 to 2300	1400	10	49.5	55	60	Terminal Blocks

* The forward voltage (V_f) of the LED load should not exceed $V_{out Max.}$ of the driver under worst case field operating conditions which are the $V_f max.$ of the LED load under lowest temperature and highest forward current conditions. As a general design guideline, the nominal LED load V_f measured at the operating current and at room temperature should be $\leq V_{out Nom.}$ of the driver.

Notes:

- Please order the programming wand using the part number PROG-JACK-USB.

Programming Cable

Part number: PROG-JACK-USB



20 to 85 W Programmable Constant Current Class 2 LED Driver with 0-10 V Dimming

2 – OPERATING ENVELOPES

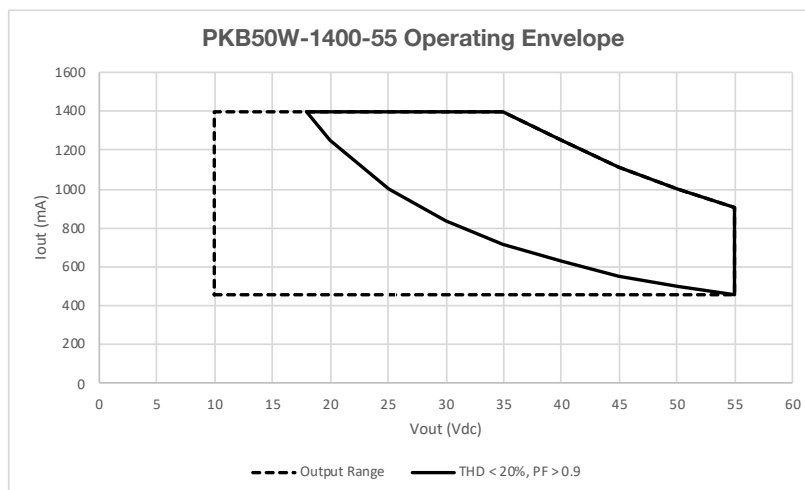
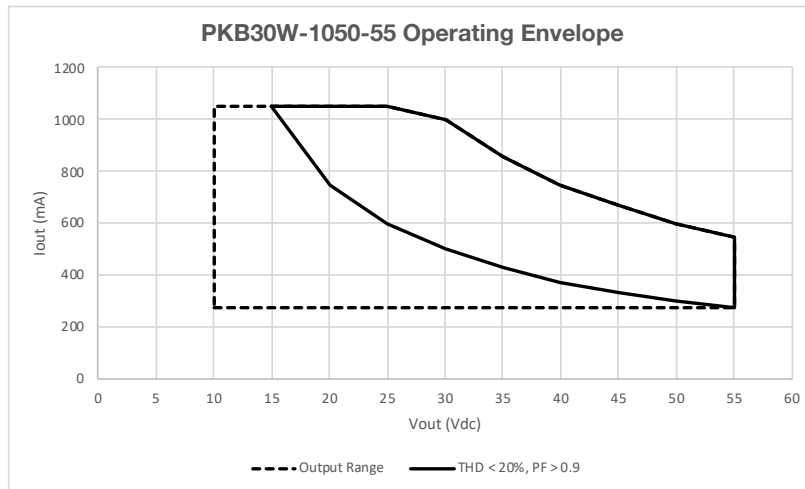
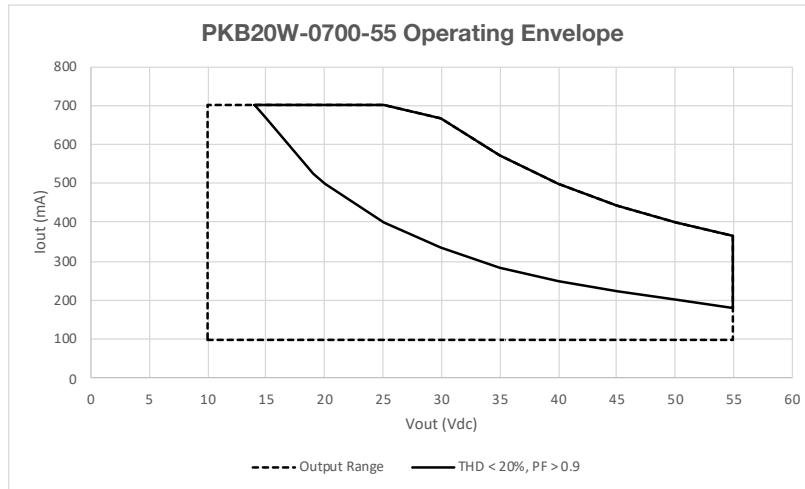

20 to 85 W Programmable Constant Current Class 2 LED Driver with 0-10 V Dimming

2 – OPERATING ENVELOPES (CONTINUED)

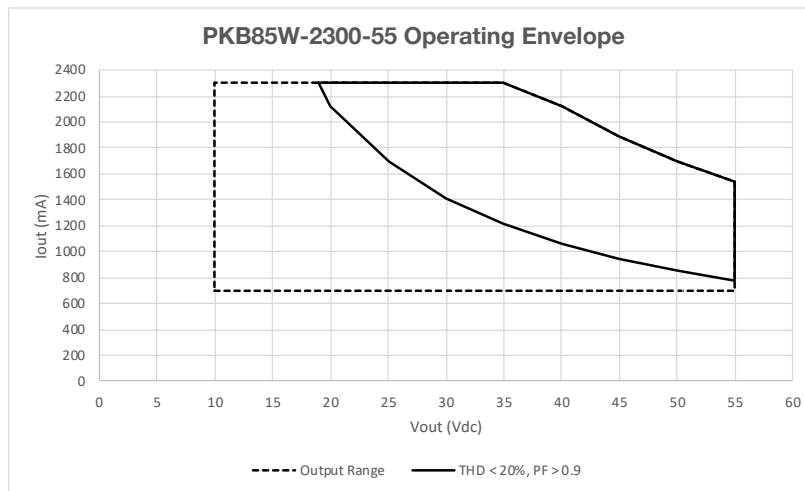
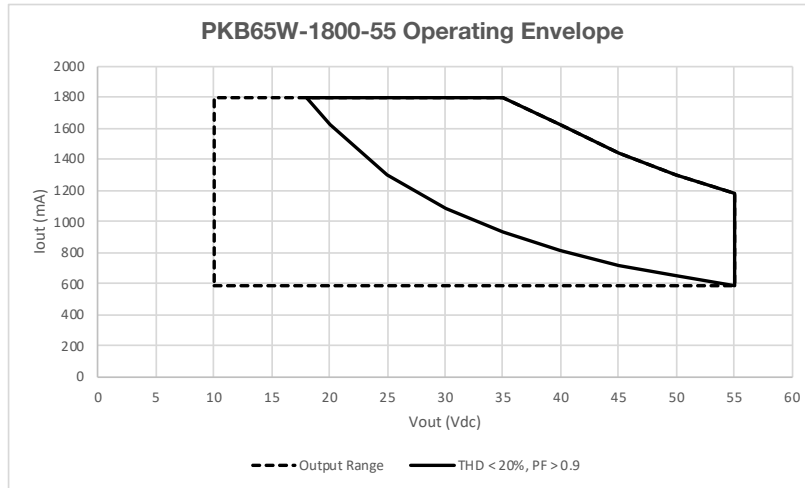

20 to 85 W Programmable Constant Current Class 2 LED Driver with 0-10 V Dimming

3 - INPUT SPECIFICATION (@25°C ambient temperature)

	Units	Minimum	Typical	Maximum	Notes
Input Voltage Range (Vin)	Vac	90	120, 277	305	<ul style="list-style-type: none"> The rated output current for each model is achieved at $V_{in} \geq 108$ Vac, & at $V_{in} \geq 249$ Vac. At nominal load
Input Frequency Range	Hz	47	50/60	63	
Input Current (Iin)	A			0.7 A @ 120 Vac 0.34 A @ 277 Vac	
Power Factor (PF)		0.9	> 0.9		<ul style="list-style-type: none"> At nominal input voltage (120 & 277 Vac) and no dimmer From 100% to 50% of output power
Inrush Current	A	Meets NEMA-410 requirements			At any point on the sine wave and 25°C
Leakage Current	mA			0.4 mA @ 120 Vac 0.75 mA @ 277 Vac	Measured per IEC60950-1
Input Harmonics	Complies with IEC61000-3-2 for Class C equipment				
Total Harmonics Distortion (THD)				20%	<ul style="list-style-type: none"> At nominal input voltage (120 & 277 Vac) From 100% to 50% of output power Complies with DLC (Design Light Consortium) technical requirements
Efficiency	%	-	up to 90%	-	Measured with nominal input voltage, a full sinusoidal wave form and without dimmer attached.
Isolation	The AC input to the main DC output is isolated.				

4 - MAIN OUTPUT SPECIFICATION (@25°C ambient temperature)

	Units	Minimum	Typical	Maximum	Notes
Output Voltage (Vout)	Vdc				See ordering information for details
Output Current (Iout)	mA				<ul style="list-style-type: none"> See ordering information for details Output voltage and current combination cannot exceed max power output. See page 3 for operating window The rated output current for each model is achieved at $V_{in} \geq 108$ Vac & $V_{in} \geq 249$ Vac.
Output Current Regulation	%	-5	±2.5	5	<ul style="list-style-type: none"> At nominal AC line voltage (120 & 277 Vac) Includes load and current set point variations
Output Current Overshoot	%	-	-	20	The driver does not operate outside of the regulation requirements for more than 500 ms during power on with nominal LED load and without dimmer.
Ripple Current	≤ 20% of rated output current for each model				<ul style="list-style-type: none"> Measured at nominal LED voltage and nominal input voltage without dimming Calculated in accordance with the IES Lighting Handbook, 9th edition
Dimming Range	%	1		100	<ul style="list-style-type: none"> The dimming range is dependent on each specific dimmer. It may not be able to achieve 1% dimming with some dimmers. When testing, if light is measured, dimming range is based on light output. If no light is measured, dimming range is based on percentage of output current. Dimming performance is optimal when the driver is operated at its nominal output voltage matching the LED nominal Vf (forward voltage). Dimming performance may vary when the driver is operated near its minimum output voltage.
Start-up Time	ms		300	500	<ul style="list-style-type: none"> Without any dimmer attached, and at nominal input voltages and nominal load Measured from application of AC line voltage to 100% light output Complies with ENERGY STAR® luminaire specification and CA Title 24
Isolation	The main DC output is certified and tested per UL8750 Class 2 or LED Class 2.				

20 to 85 W Programmable Constant Current Class 2 LED Driver with 0-10 V Dimming

5 - 0-10 V DIMMING CONTROL (@25°C ambient temperature)

In the PKB series, several 0-10V dimming profiles can be selected, such as a logarithmic profile, a non-linear profile with 1% minimum dimming, and a non-linear profile with 10% minimum dimming. Furthermore, every point in the non-linear dimming profile can be programmed using the programming software.

By default, the non-linear profile with 1% minimum dimming (shown in figure 1) is pre-loaded in the PKB series.

	Units	Minimum	Typical	Maximum	Notes
+Dim Signal, -Dim Signal	The PKB series operate only with 0-10 V dimmers that sink current. The method to dim the output current of the driver is done via the +Dim/-Dim Signal pins. The +Dim/-Dim signal pins can be used to adjust the output setting via a standard commercial wall dimmer, an external control voltage source (0 to 10 Vdc), or a variable resistor when using the recommended number of LEDs. The dimming input permits 1% to 100% dimming.				
Dimming Profile (see figure 1)	100% of output current between 10 V and 8.2 V, Linear between 8.2 V and 1.5 V, 1% of output current below 1.5 V.				
Dimming Range	%	1		100	When testing, if light is measured, dimming range is based on light output. If no light is measured, dimming range is based on percentage of output current.
High Level Voltage - A	V		8.2	8.5	
Low Level Voltage - B	V	0.5	1.5		
Current Supplied by the +Dim Signal Pin	mA			1	
Dimming Voltage Sensing Tolerance	mV			100	The tolerance of the difference between the 0-10 V signal supplied by the dimmer and sensed by the driver.
Output Current Tolerance While Being Dimmed	%		±8		In the linear region of the dimming curve (Between points A and B in Figure 1).
Output Current Tolerance at Minimum Dimming	%		±8		The tolerance of the output current at minimum dimming is +/-8% of 1% of the maximum output current of each driver.
Minimum Dimming Tolerance	%	0.8	1	2	
Isolation	The 0-10 V circuit is isolated from the AC input and meets UL8750 supplement SF requirements.				

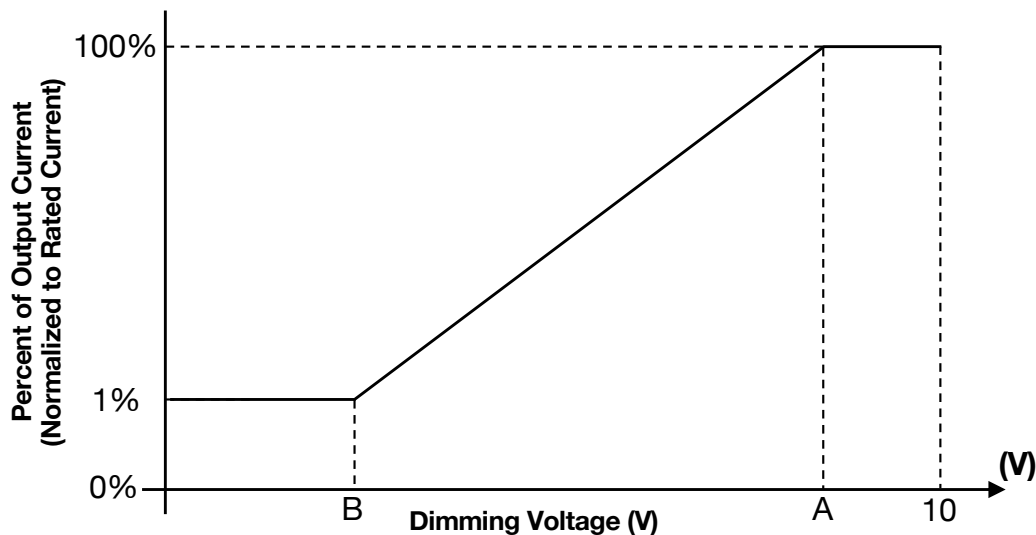

Figure 1

20 to 85 W Programmable Constant Current Class 2 LED Driver with 0-10 V Dimming

6 - ENVIRONMENTAL CONDITIONS

	Units	Minimum	Typical	Maximum	Notes
Operating Ambient Temperature (Ta)	°C	-20		50	50°C is the non-derated temperature (Refer to section 9 'Output power de-rating at elevated temperatures'.)
Maximum Case Temperature (Tc)	°C			+90	Case temperature measured at the hot spot •tc (see label on page 16)
Storage Temperature	°C	-40		+85	
Humidity	%	5	-	95	Non-condensing
Cooling	Convection cooled				
Acoustic Noise	dBA			24	Measured at a distance of 1 foot, without dimmer
Mechanical Shock Protection	per EN60068-2-27				
Vibration Protection	per EN60068-2-6 & EN60068-2-64				
MTBF	> 200,000 hours when operated at nominal input and output conditions, and at Tc ≤ 75°C				
Lifetime	50,000 hours at Tc ≤ 75°C maximum case hot spot temperature (see hot spot •tc on label on page 16)				
Warranty	5 years. Users must utilize proper thermal management techniques to ensure proper thermal conductivity between the driver and heat sink. The use of double-sided tape to mount the driver voids the warranty.				

7 - EMC COMPLIANCE, SAFETY, AND ENVIRONMENTAL APPROVALS

EMC Compliance

Conducted and Radiated EMI	•Compliant with FCC CFR Title 47 Part 15 Class A at 120 & 277 Vac		
Harmonic Current Emissions	IEC61000-3-2	For Class C equipment	
Voltage Fluctuations & Flicker	IEC61000-3-3		
Immunity Compliance	ESD (Electrostatic Discharge)	IEC61000-4-2	6 kV contact discharge, 8 kV air discharge, level 3
	RF Electromagnetic Field Susceptibility	IEC61000-4-3	3 V/m, 80 - 1000 MHz, 80% modulated at a distance of 3 meters
	Electrical Fast Transient	IEC61000-4-4	± 2 kV on AC power port for 1 minute, ±1 kV on signal/control lines
	Surge	IEC61000-4-5	± 2 kV line to line (differential mode) / ± 2 kV line to common mode ground
		ANSI/IEEE c62.41.1-2002 & c62.41.2-2002 category A, 2.5 kV ring wave	
	Conducted RF Disturbances	IEC61000-4-6	3V, 0.15-80 MHz, 80% modulated
Voltage Dips	IEC61000-4-11	>95% dip, 0.5 period; 30% dip, 25 periods; 95% reduction, 250 periods	

Safety & Environmental Approvals

UL	UL8750 listed Class 2, supplement SF
cUL	CAN/CSA C22.2 No. 250.13-14 LED equipment for lighting applications
NOM	
Declare	LBC (Living Building Challenge) Red List Approved

Safety

	Units	Minimum	Typical	Maximum	Notes
Hi Pot (High Potential) or Dielectric voltage-withstand	Vdc	2200			•Tested at the RMS voltage equivalent of 1555 Vac

20 to 85 W Programmable Constant Current Class 2 LED Driver with 0-10 V Dimming

8 - PROTECTION FEATURES

Input Over Current Protection

The PKB series incorporates a primary AC line fuse for input over current protection to prevent damage to the LED driver and meet product safety requirements as outlined in Section 6.

Short Circuit and Over Current Protection

The PKB series is protected against short-circuit such that a short from any output to return shall not result in a fire hazard or shock hazard. The driver shall hiccup as a result of a short circuit or over current fault. Removal of the fault will return the driver to within normal operation. The driver shall recover, with no damage, from a short across the output for an indefinite period of time.

Internal Over temperature Protection

The PKB series is equipped with internal temperature sensor on the primary power train. Failure to stay within the convection power rating will result in the power supply reducing the available current (fold back) below the programmed amount. The main output current will be restored to the programmed value when the temperature of the built-in temperature sensor cools adequately.

Output Open Load Protection

When the LED load is removed, the output voltage of the PKB series is typically limited to 1.3 times the maximum output voltage of each model.

9 - OUTPUT POWER DE-RATING AT ELEVATED TEMPERATURES

The PKB series can be operated with cooling air temperatures above 50°C by linearly de-rating the total maximum output power (or current) by 2.5%/°C until internal over temperature protection activates.

20 to 85 W Programmable Constant Current Class 2 LED Driver with 0-10 V Dimming

10 - 0-10 V DIMMING

The PKB series operate only with 0-10 V dimmers that sink current. They are not designed to operate with 0-10 V control systems that source current, as used in theatrical/entertainment systems. Developed in the 1980's, the 0-10 V sinking current control method is adopted by the International Electrotechnical Commission (IEC) as part of its IEC Standard 60929 Annex E.

The method to dim the output current of the driver is done via the +Dim/-Dim Signal pins. The +Dim/-Dim Signal pins respond to a 0 to 10 V signal, delivering 1% to 100% of the output current based on rated current for each model. A pull-up resistor is included internal to the driver. If the +Dim input is > 10 V or open circuited, the output current is programmed to 100% of the rated current.

The maximum source current (flowing from the driver to the 0-10 V dimmer) supplied by the +Dim Signal pin is ≤ 1 mA. The tolerance of the output current while being dimmed shall be $\pm 8\%$ typical until down to 1.5 V.

In the PKB series, several 0-10 V dimming profiles can be selected, such as a logarithmic profile, a non-linear profile with 1% minimum dimming, and a non-linear profile with 10% minimum dimming.

By default, the non-linear profile with 1% minimum dimming (shown in figure 2) is pre-loaded in the PKB series. In this non-linear 0-10 V dimming profile, 10 V to 8.2 V = 100% of the output current, < 1.5 V = 1%,

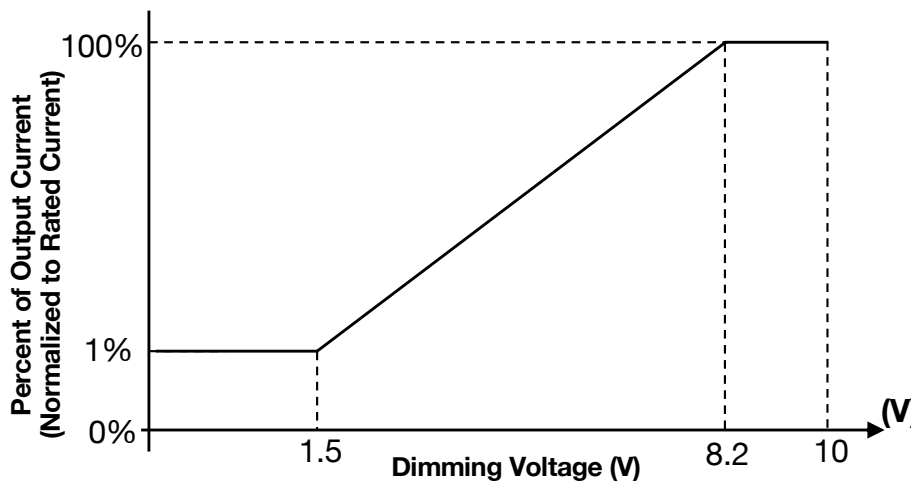

Figure 2

11 - COMPATIBLE 0-10 V DIMMERS

- Lutron, Nova series (part number NFTV)
- Lutron, Diva series (part number DVTV)
- Leviton, IllumaTech series (part number IP710-DL)

20 to 85 W Programmable Constant Current Class 2 LED Driver with 0-10 V Dimming

12 - PROGRAMMING

The PKB series can be programmed by inserting the audio jack of the cable shown in figure 3 into the driver and by plugging the USB other end of the cable into a computer. **The driver should not be powered on during the programming process.**

When ordering the PKB series, please make sure you order a programming cable. The part number for the programming cable is “PROG-JACK-USB”.

Programming is done by using the ERP GUI (Graphical User Interface), which enables the user to adjust output current and dimming profile.

Please note that, for each model, the **default output current setting is listed on page 2 of this datasheet.**

Furthermore, when connecting the driver to a computer using the programming cable, you can access the driver’s internal data log and read the following information: SKU, serial number, manufacturing lot code, hours of operation, firmware revision, and power cycles.

While programming drivers in a lot, the ERP GUI can interface with a label printer, which enables the user to add configuration labels to driver labels in order to highlight programmed output current. Listed below is the equipment needed to print labels.

Equipment	Part Number	Where to buy
Printer	TSC TC210	barcodefactory.com/tsc/printers/tc210/99-059a001-54lf
Ribbon	TSC Prem. Resin, 60mm x 110mm	barcodefactory.com/tsc/35-r060110-23cf
Labels	BAR-.81x.28-1-TT	barcodefactory.com/barcodefactory/labels/bar-.81x.28-1-tt

For more information, please refer to the GUI user’s manual at: erp-power.com/our-products/programming-software/



Figure 3

20 to 85 W Programmable Constant Current Class 2 LED Driver with 0-10 V Dimming

13 - PREDICTED LIFETIME VERSUS CASE AND AMBIENT TEMPERATURE

Lifetime is defined by the measurement of the temperatures of all the electrolytic capacitors whose failure would affect light output under the nominal LED load and worst case AC line voltage. The graphs in figures 4 and 5 are determined by the electrolytic capacitor with the shortest lifetime, among all electrolytic capacitors. It represents a worst case scenario in which the LED driver is powered 24 hours/day, 7 days/week. The lifetime of an electrolytic capacitor is measured when any of the following changes in performance are observed:

- | | |
|--|--|
| 1) Capacitance changes more than 20% of initial value | 2) Dissipation Factor ($\tan \delta$): 150% or less of initial specified value |
| 3) Equivalent Series Resistance (ESR): 150% or less of initial specified value | 4) Leakage current: less of initial specified value |

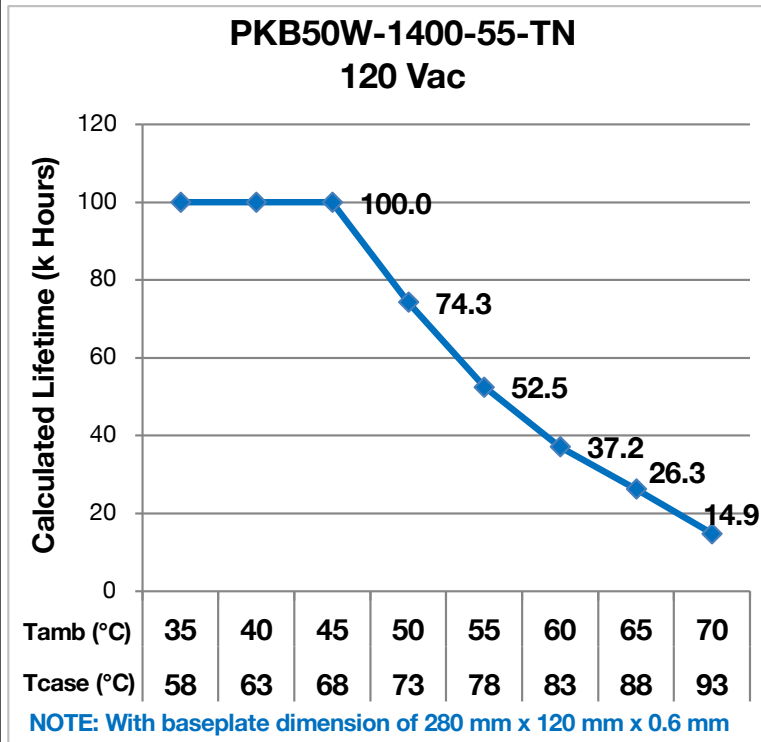

Figure 4

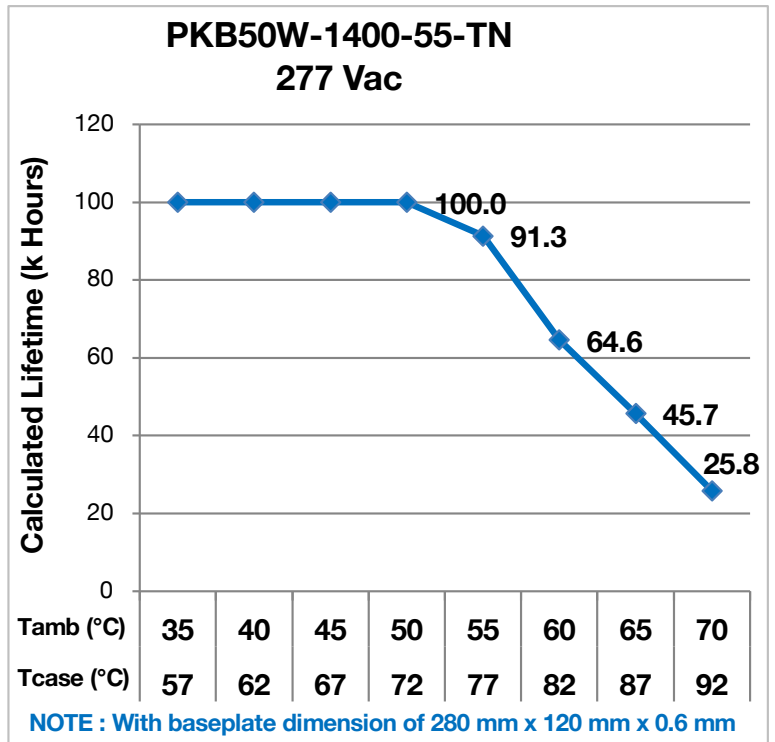

Figure 5

- Notes:
- The ambient temperature $T_{ambient}$ and the differential between $T_{ambient}$ and T_{case} mentioned in the above graphs are relevant only as long as both the driver and the light fixture are exposed to the same ambient room temperature. If the LED driver is housed in an enclosure or covered by insulation material, then the ambient room temperature is no longer valid. In this situation, please refer only to the case temperature T_{case} .
 - It should be noted the graph "Lifetime vs. Ambient Temperature" may have an error induced in the final application if the mounting has restricted convection flow around the case. For applications where this is evident, the actual case temperature measured at the Tc point in the application should be used for reliability calculations.
 - Users must utilize proper thermal management techniques to ensure proper thermal conductivity between the driver and heat sink. The use of double-sided tape to mount the driver voids the warranty.

20 to 85 W Programmable Constant Current Class 2 LED Driver with 0-10 V Dimming

14 – EFFICIENCY VERSUS OUTPUT VOLTAGE (100% OF IOUT)

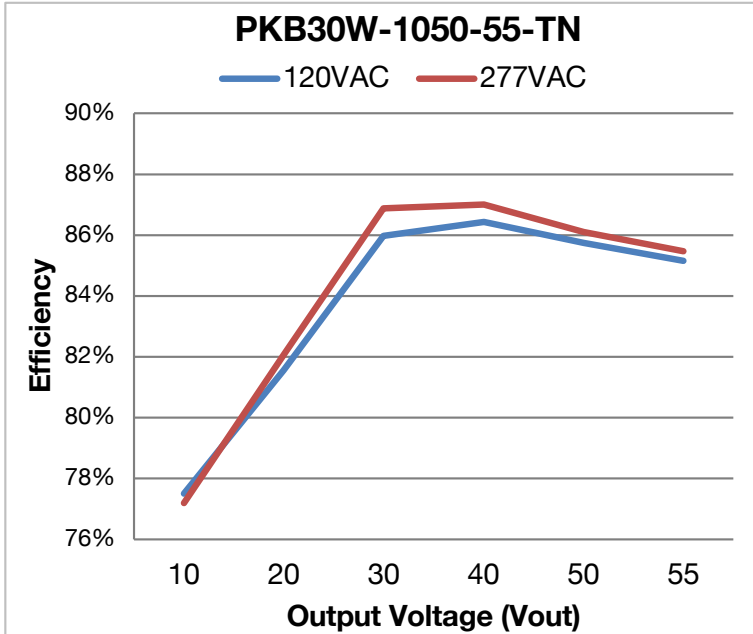

Figure 6

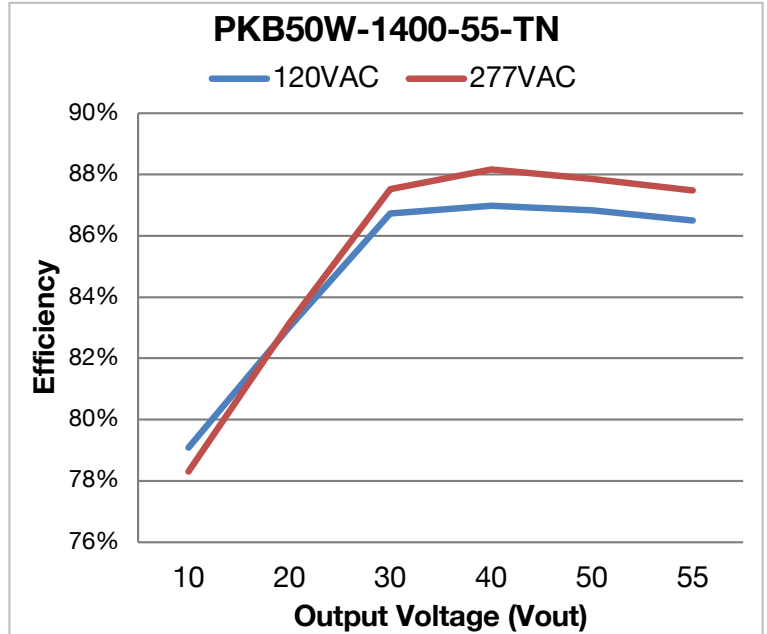

Figure 7

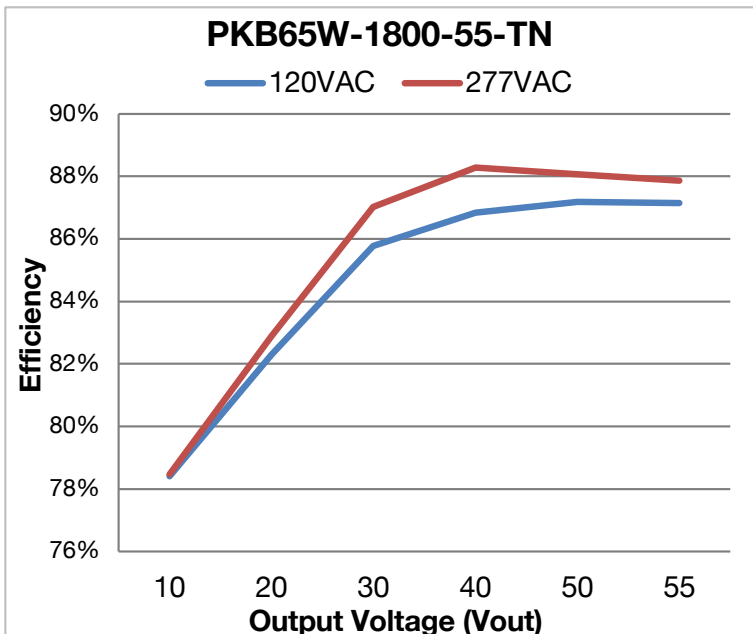

Figure 8

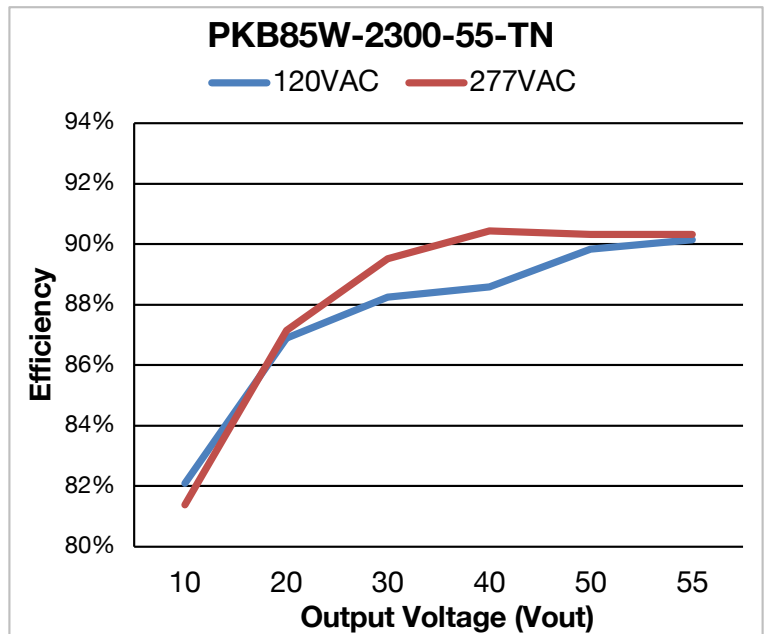

Figure 9

20 to 85 W Programmable Constant Current Class 2 LED Driver with 0-10 V Dimming

15 – POWER FACTOR VERSUS OUTPUT VOLTAGE (100% OF IOUT)

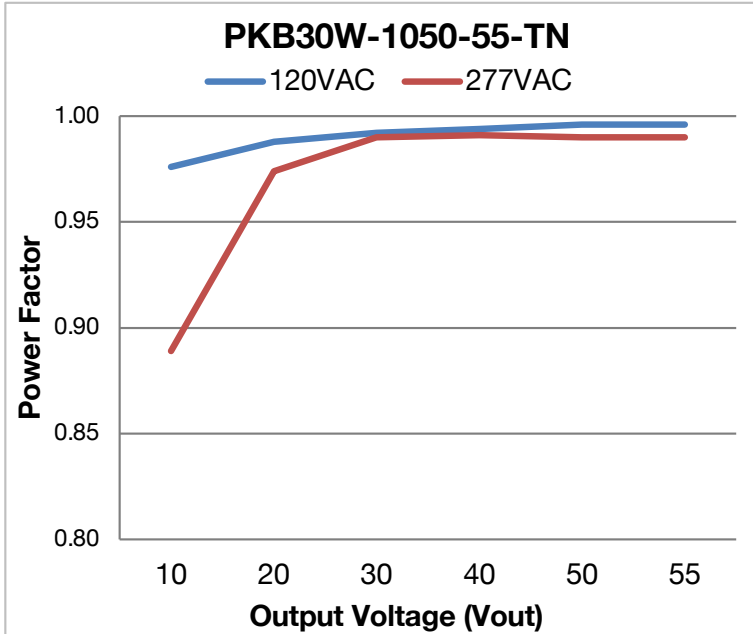

Figure 10

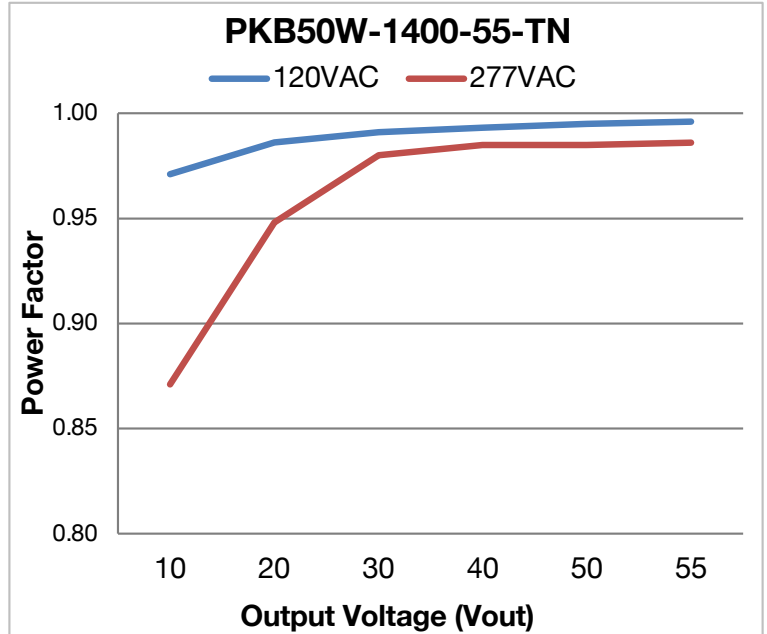

Figure 11

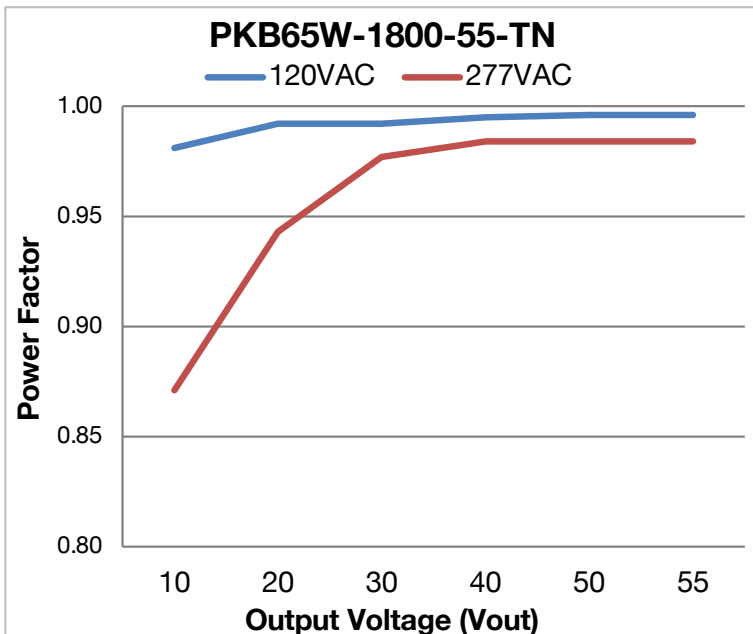

Figure 12

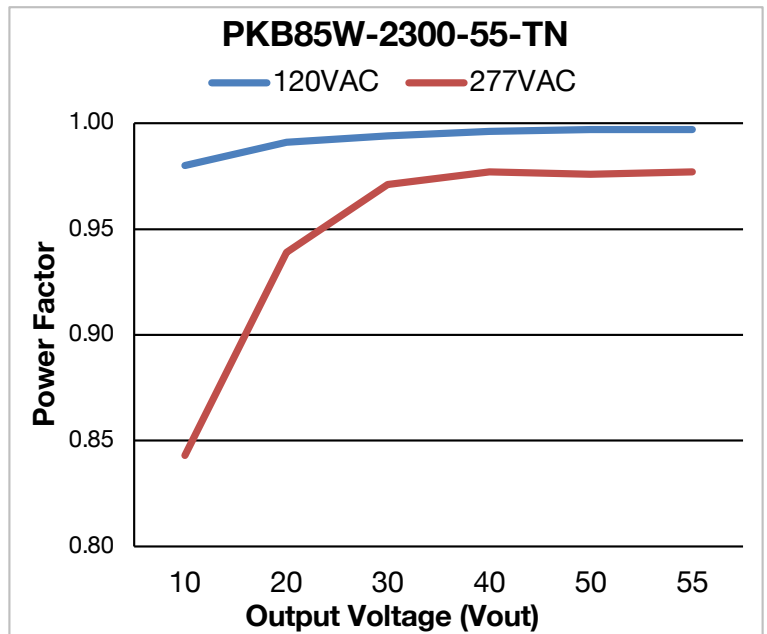

Figure 13

20 to 85 W Programmable Constant Current Class 2 LED Driver with 0-10 V Dimming

16 - THD VERSUS OUTPUT VOLTAGE (100% OF IOU)

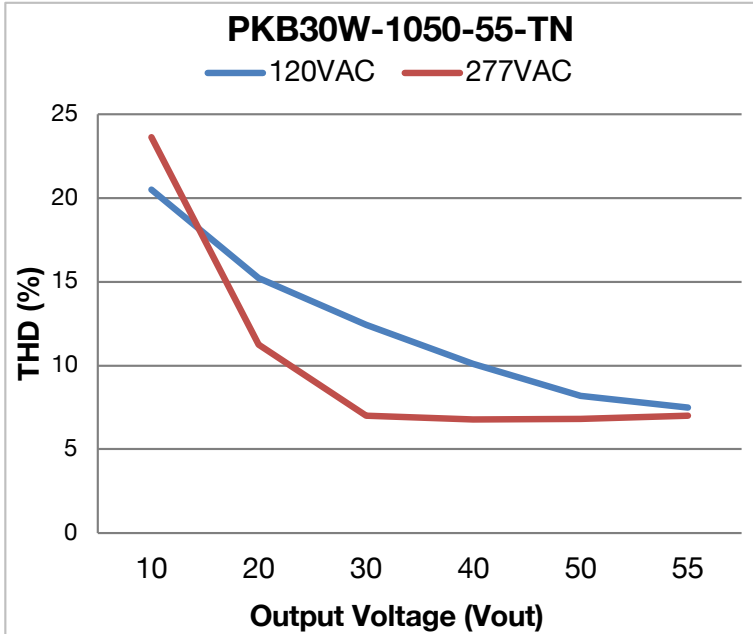

Figure 14

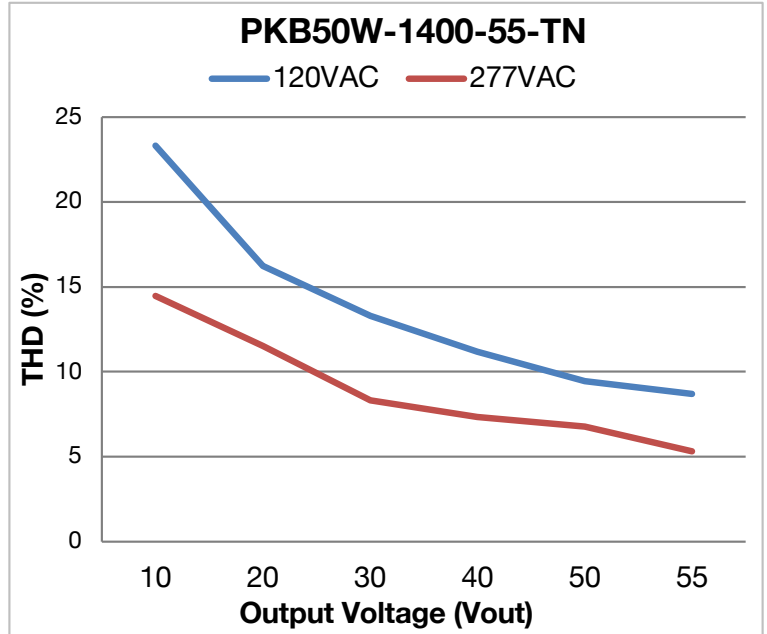

Figure 15

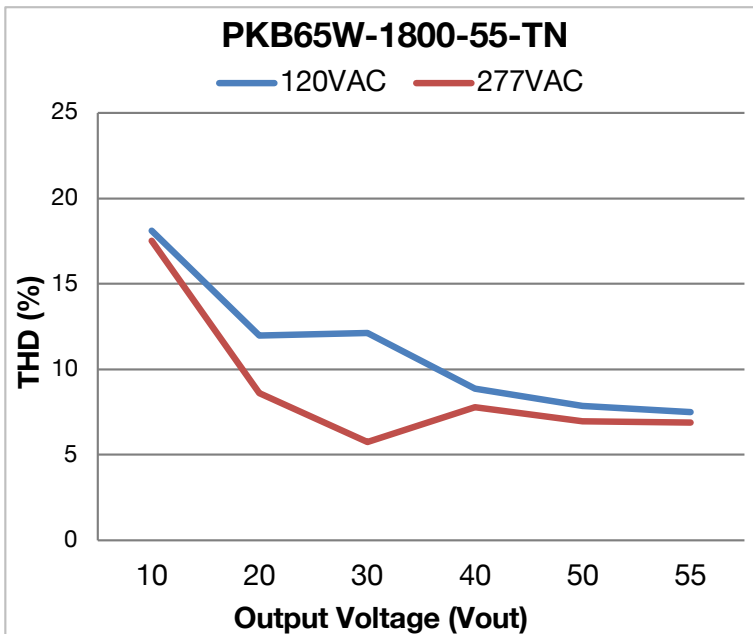

Figure 16

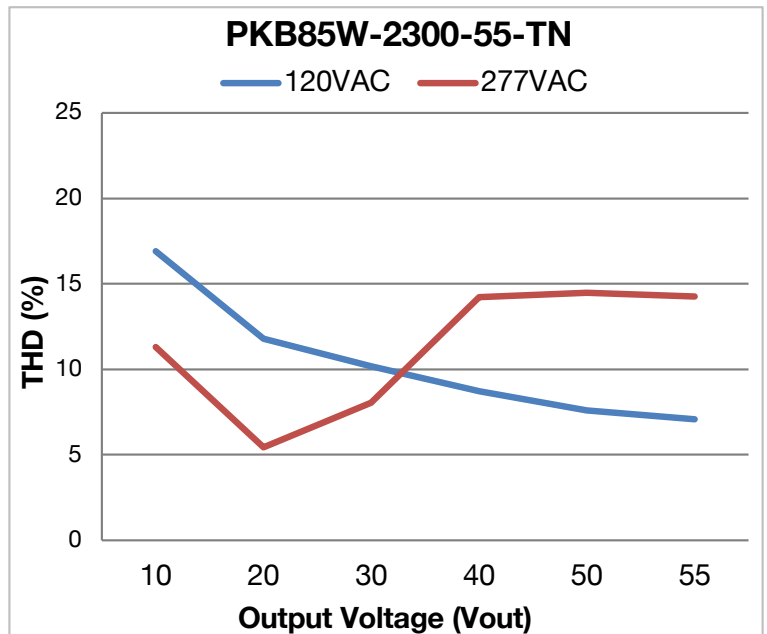

Figure 17

20 to 85 W Programmable Constant Current Class 2 LED Driver with 0-10 V Dimming

17 - MECHANICAL DETAILS

- **Packaging:** Aluminum case
- **I/O Connections:**
 - **Models with "TN" suffix:** Terminal Blocks
- **Ingress Protection:** IP20 rated
- **Mounting Instructions:** The PKB driver case must be secured on a flat surface through the two mounting tabs, shown here below in the case outline drawings. The use of double-sided tape voids the warranty.

18 - OUTLINE DRAWINGS

Dimensions: L 257 x W 29.4 x H 25.1 mm (L 10.12 x W 1.16 x H 0.99 in.)

Volume: 189.7 cm³ (11.6 in³)

Weight: 240 g (8.5 oz)

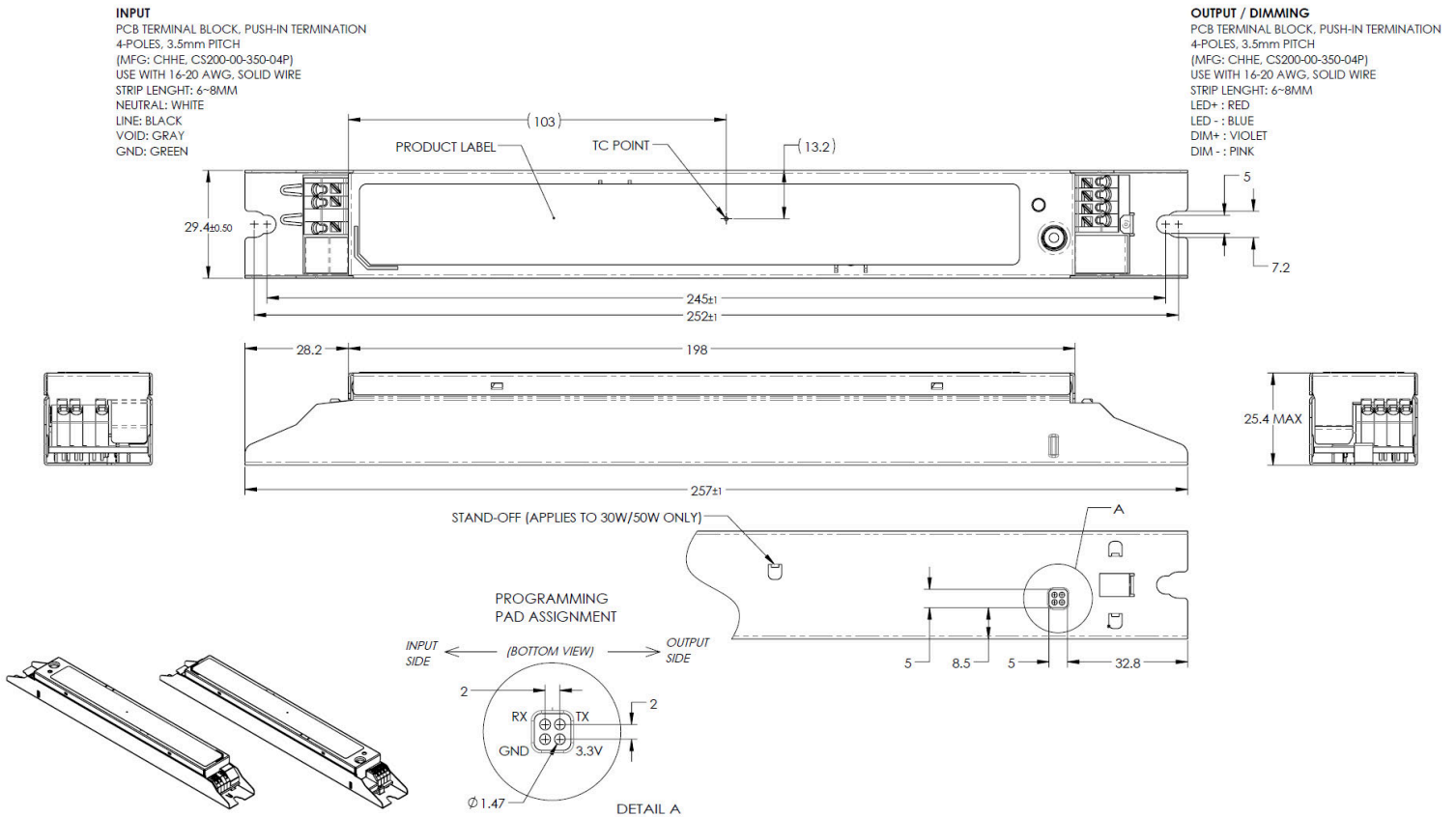

All dimensions are in mm

Figure 18

20 to 85 W Programmable Constant Current Class 2 LED Driver with 0-10 V Dimming

19 - LABELING

The PKB65W-1800-55-TN is used in figure 19 as an example to illustrate a typical label.

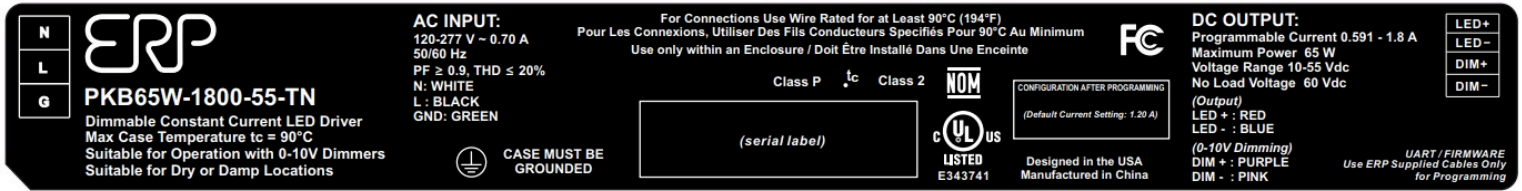

Figure 19

USA Headquarters

Tel: +1-805-517-1300
Fax: +1-805-517-1411
2625 Townsgate Road, Suite 106
Westlake Village, CA 91361, USA

CHINA Operations

Tel: +86-756-6266298
Fax: +86-756-6266299
No. 8 Pingdong Road 2
Zhuhai, Guangdong, China 519060

ERP Power, LLC (ERP) reserves the right to make changes without further notice to any products herein. ERP makes no warranty, representation or guarantee regarding the suitability of its products for any particular purpose, nor does ERP assume any liability arising out of the application or use of any product or circuit, and specifically disclaims any and all liability, including without limitation special, consequential or incidental damages. "Typical" parameters which may be provided in ERP data sheets and/or specifications can and do vary in different applications and actual performance may vary over time. All operating parameters, including "Typicals" must be validated for each customer application by customer's technical experts. ERP does not convey any license under its patent rights nor the rights of others. ERP products are not designed, intended, or authorized for use as components in systems intended for surgical implant into the body, or other applications intended to support or sustain life, or for any other application in which the failure of the ERP product could create a situation where personal injury or death may occur. Should Buyer purchase or use ERP products for any such unintended or unauthorized application, Buyer shall indemnify and hold ERP and its officers, employees, subsidiaries, affiliates, and distributors harmless against all claims, costs, damages, and expenses, and reasonable attorney fees arising out of, directly or indirectly, any claim of personal injury or death associated with such unintended or unauthorized use, even if such claim alleges that ERP was negligent regarding the design or manufacture of the part. ERP is an Equal Opportunity/Affirmative Action Employer. This literature is subject to all applicable copyright laws and is not for resale in any manner.

20 to 85 W Programmable Constant Current Class 2 LED Driver with 0-10 V Dimming

Revision History

Date	Comments
20NOV2020	• Initial Release
11JAN2021	• Pg3: correct Vin in output current section
06APR2021	• Added PKB65W characterization curves
24SEP2021	• Clarified input voltage
07DEC2021	• Added “-TN” part numbers
19JAN2022	• Added NOM Certification
16MAR2022	• Pg15: updated label
28MAR2023	<ul style="list-style-type: none"> • Pg1: added RoHS logo • Pg2: removed “-TD” part numbers • Pg5,8: corrected dimming voltage values for default dimming profile • Pg14: updated mechanical case outline
21SEP2023	• Pg5: Added dimming voltage sensing tolerance
14FEB2024	• Added PKB20, PKB80